

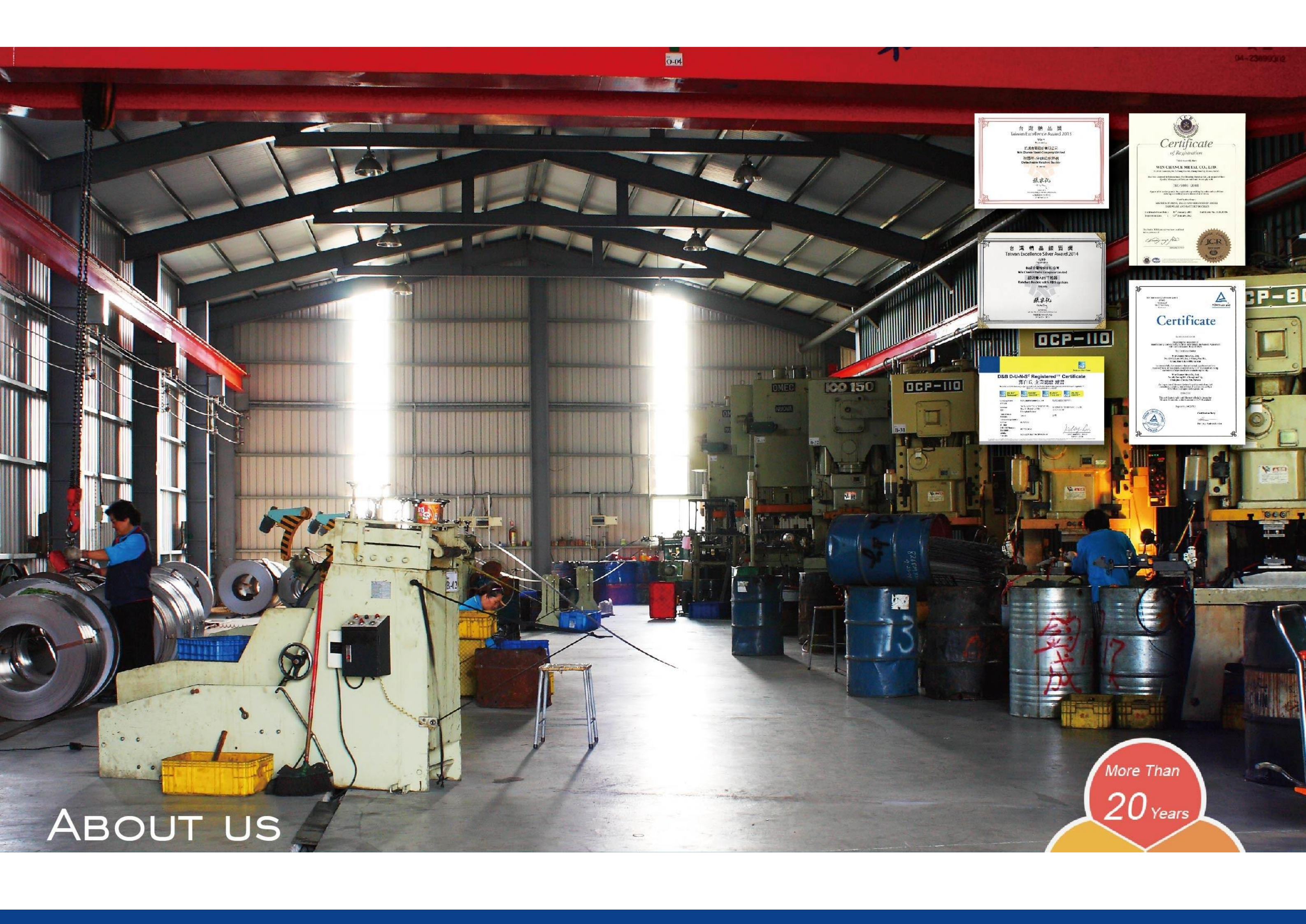

 **Bright Creation** Taiwan  
Professional supplier since 1991



0-04

04-2389302



ABOUT US

More Than  
20 Years

# Content

## RATCHET BUCKLE

A.B.S Series	04
Extendable Series	05
Detachable Series	06
Retractable Series	07
Stainless Series	08
Aluminum Series	09
Ergonomic Rubber Grip Series	10
Conjoined Hook Series	11
Traditional Series	12
Multi-function Super RatchetBuckle	14
Ratchet Load Binder	14
Roller Chain Binder	15
Chain Binder	15

## RATCHET TIE DOWN

16

## LEVER BLOCK

18

## CAM BUCKLE

19

## STAMPING PARTS

20

## WIRE FORMING PARTS

Ring	22
Buckle	23
Hook	24
J Hook	26
S Hook	28
Bolt	29

## FITTING

30

## FORGING PARTS

31

## FALL PROTECTION

32

Steel Carabiner	34
Aluminum Carabiner	37
Fall Protection For Tools	39
Snap Hook	39
Safety Buckle	41
Swivel Connector	41



PRECISION PUNCHING MACHINE

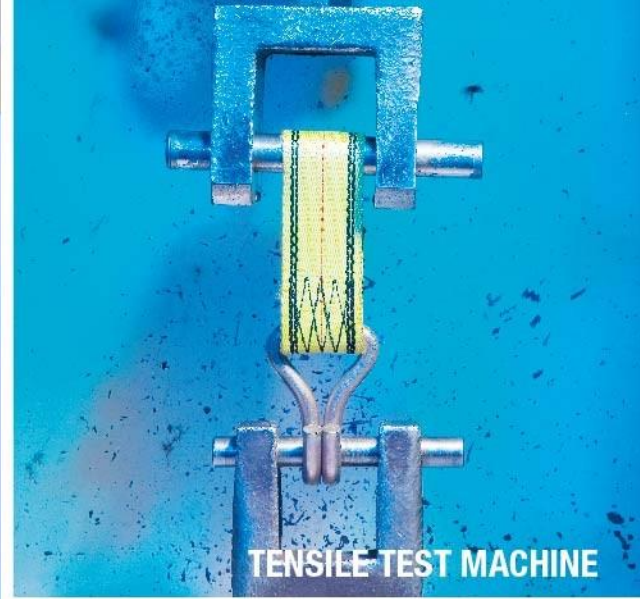

TENSILE TEST MACHINE



SAND BLASTING MACHINE



SALT SPRAY TEST MACHINE

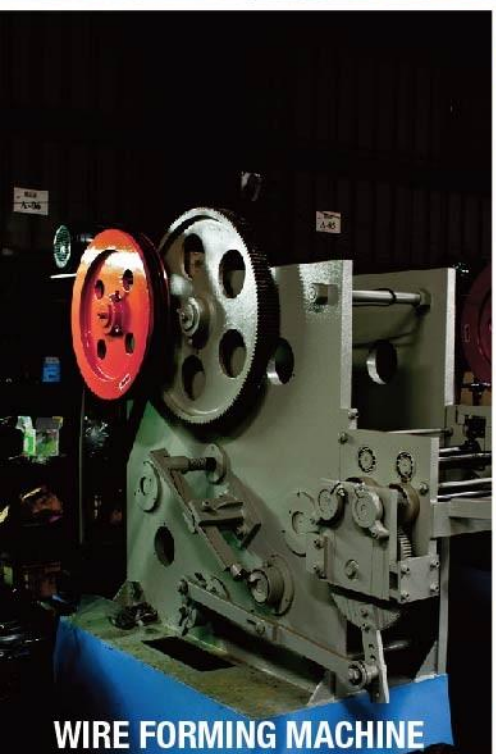

WIRE FORMING MACHINE



AUTOMATIC SPRING MACHINE



PRECISION PUNCHING MACHINE

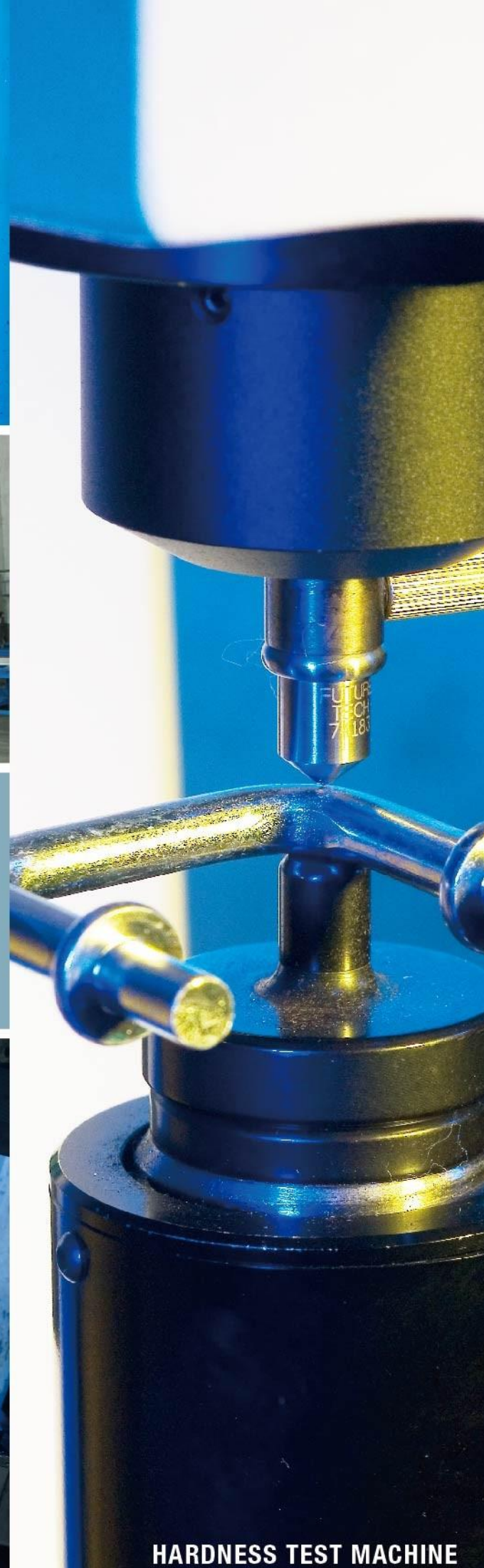

HARDNESS TEST MACHINE

## RATCHET BUCKLE

# A.B.S Series

Ideal for commercial use.  
Heavy duty load securing preferred.  
Built-in safety device for slow down the release during off-load.  
Ergonomic wide plastic grip for ease operation.

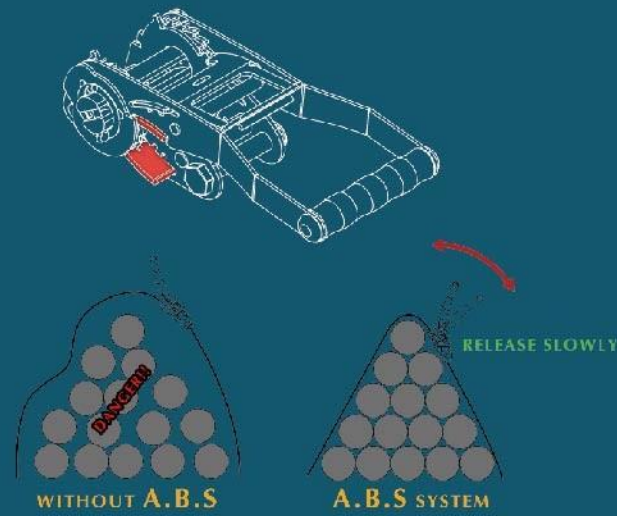

## RATCHET BUCKLE

# Extendable Series

Made for diagonal lashing.  
Powerful working ability.  
Telescopic handle for better pre-tension.

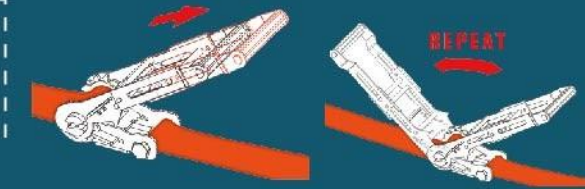

**MORE LEVERAGE**



**2" A.B.S Ratchet Buckle  
RB51R-001**

Size: 2"/50mm  
B.S: 5000kg  
Finish: Zinc & Electric Black  
Long lever type  
Ergonomic wide plastic grip



**2" Extendable A.B.S Ratchet Buckle  
RB51ER-001**

Size: 2"/50mm  
B.S: 5000kg  
Finish: Zinc & Electric Black  
Extendable handle type  
Aluminum grip  
\*EN 12195-2: 2000 certified



**2" Extendable Ratchet Buckle  
RB51E-001**

Size: 2"/50mm  
B.S: 5000kg  
Finish: Zinc & Electric Black  
Extendable handle type  
Aluminum grip  
\*EN 12195-2: 2000 certified



**2" Extendable Ratchet Buckle  
RB51E-005**

Size: 2"/50mm  
B.S: 5000kg  
Finish: Zinc & Electric Black  
Extendable handle type  
Aluminum grip  
Reverse function



**2" Extendable A.B.S Ratchet Buckle  
RB51ER-006**

Size: 2"/50mm  
B.S: 5000kg  
Finish: Zinc & Electric Black  
Extendable handle type  
Aluminum grip  
Reverse-Gear



**1.5" A.B.S Ratchet Buckle  
RB43R-001**

Size: 1.5"/35mm  
B.S: 3000kg  
Finish: Zinc & Electric Black  
Aluminum grip



**3" Extendable Ratchet Buckle  
RB76E-001**

Size: 3"/75mm  
B.S: 10000kg  
Finish: Zinc & Electric Black  
Extendable handle type  
Aluminum grip



**4" Extendable Ratchet Buckle  
RB101E-001**

Size: 4"/100mm  
B.S: 10000kg  
Finish: Zinc & Electric Black  
Extendable handle type  
Aluminum grip

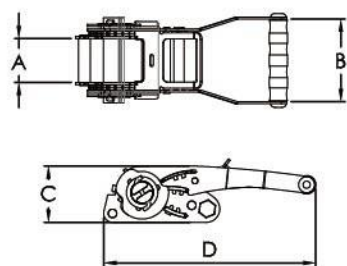

Item No.	A mm	B mm	C mm	D mm
RB51R-001	52	98	67	252
RB51ER-001	52	98	67	274/332
RB51ER-006	52	98	66	334/410
RB43R-001	42	66	68	252

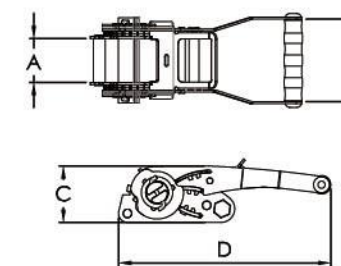

Item No.	A mm	B mm	C mm	D mm
RB51E-001	54	98	56	242/300
RB51E-005	52	98	52	280/338
RB76E-001	76	109	77	363/488
RB101E-001	101	134	77	363/488

## RATCHET BUCKLE

# Detachable Series

Ideal for trucks and long-way deliveries.  
 Meet environment protection and energy saving trendy.  
 Prevent unauthority off-load - the ratchet is not able to be loosened without handle.  
 Space saving and weight reduction.  
 Freely matching handle and ratchet-body as packs.

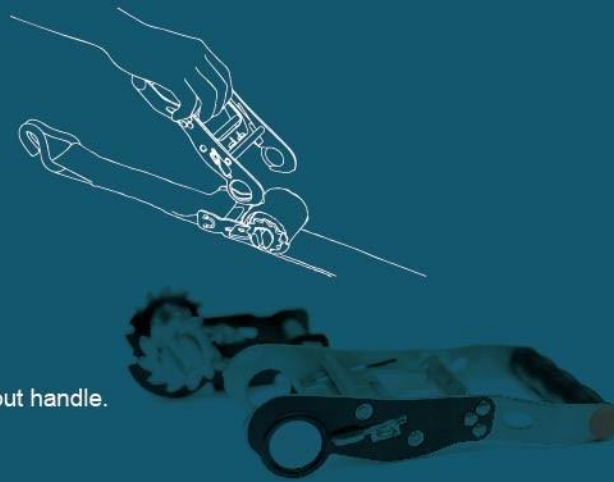

## RATCHET BUCKLE

# Retractable Series

Heavy-duty cargo lashing strap preferred.  
 Long lever for better pre-tension force.  
 Rotatable device for easier webbing adjustment and storage.  
 Includes highly stretched fabric.

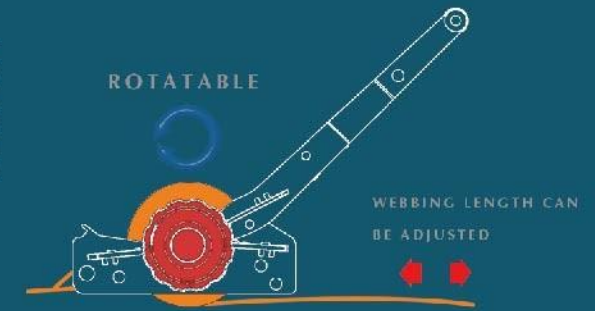

**2" Detachable Ratchet Buckle**  
**RB51AB-001**

Size: 2"/50mm  
 B.S: 5000kg  
 Finish: Zinc & Electric Black  
 Removable handle type  
 Ergonomic wide plastic grip  
 \*EN 12195-2: 2000 certified



**2" Detachable Ratchet Buckle**  
**RB51AB-004**

Size: 2"/50mm  
 B.S: 5000kg  
 Finish: Zinc & Electric Black  
 Removable handle type  
 Aluminum grip



**2" Stainless Detachable Ratchet Buckle**  
**RBS51AB-001**

Size: 2"/50mm  
 B.S: 2500kg  
 SUS 304  
 Removable handle type  
 Ergonomic wide plastic grip



**1.5" Detachable Ratchet Buckle**  
**RB43AB-001**

Size: 1.5"/35mm  
 B.S: 3000kg  
 Finish: Zinc & Electric Black  
 Removable handle type  
 Ergonomic wide plastic grip  
 \*EN 12195-2: 2000 certified



**1.5" Stainless Detachable Ratchet Buckle**  
**RBS43AB-001**

Size: 1.5"/35mm  
 B.S: 1500kg  
 SUS 304  
 Removable handle type  
 Ergonomic wide plastic grip



**1.5" Detachable Ratchet Buckle**  
**RB38AB-001**

Size: 1.5"/35mm  
 B.S: 2000kg  
 Finish: Zinc & Electric Black  
 Removable handle type  
 Ergonomic wide plastic grip

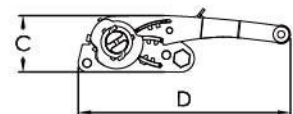
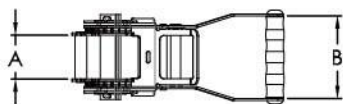

Item No.	A mm	B mm	C mm	D mm
RB51AB-001	54	98	57	211
RB51AB-004	54	98	57	211
RBS51AB-001	54	98	57	211
RB43AB-001	42	80	59	190
RBS43AB-001	42	80	44	175
RB38AB-001	42	80	42	172



**2" Long Handle Retractable Ratchet Tie Down**  
**RTDG51-002**

Size: 2"/50mm  
 B.S: 5000kg  
 Finish: Zinc & Electric Black  
 Webbing length: 5M  
 Long lever type  
 Aluminum grip  
 Double J hook ends



**1.5" Long Handle Retractable Ratchet Tie Down**  
**RTDG43-001**

Size: 1.5"/35mm  
 B.S: 3000kg  
 Finish: Zinc & Electric Black  
 Webbing length: 3M  
 Long lever type  
 Aluminum grip  
 Double J hook ends



**1.5" Middle Handle Retractable Ratchet Tie Down**  
**RTDG38-001**

Size: 1.5"/35mm  
 B.S: 1800kg  
 Finish: Zinc & Electric Black  
 Webbing length: 3M  
 Middle handle type  
 Aluminum grip  
 Double J hook ends



**1" Rubber-handled Retractable Ratchet Tie Down**  
**RTDG28-001**

Size: 1"/25mm  
 B.S: 1200kg  
 Finish: Yello Zinc  
 Webbing length: 4.5M  
 Middle handle type  
 Rubber grip  
 S hook ends



**1" Retractable Ratchet Tie Down**  
**RTDG28-002**

Size: 1"/25mm  
 B.S: 1200kg  
 Finish: Zinc & Electric Black  
 Webbing length: 2M  
 Middle handle type  
 Aluminum grip  
 S hook ends



**1" Light Duty Retractable Ratchet Tie Down**  
**RTDG24-001**

Size: 1"/25mm  
 B.S: 550kg  
 Finish: Yellow Zinc  
 Webbing length: 4.8M  
 S hook ends

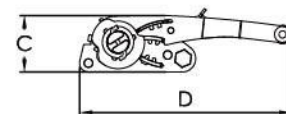
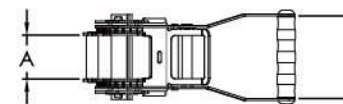

Item No.	A mm	B mm	C mm	D mm
RTD51G-002	53	98	85	350
RTD43G-001	41	80	82	280
RTD38G-001	40	80	63	215
RTD28G-001	27	90	78	168
RTD28G-002	30	60	64	148
RTD24G-001	27	38	75	135

## RATCHET BUCKLE

# Stainless Series

Ideal for commercial use.  
UV exposure tested - non-rot or weaken.  
Elegant outline and durable quality.

DURABLE, ELEGANT

## RATCHET BUCKLE

# Aluminum Series

Light-weight design.  
Better free-crossion performance.  
Elegant outline and durable quality.

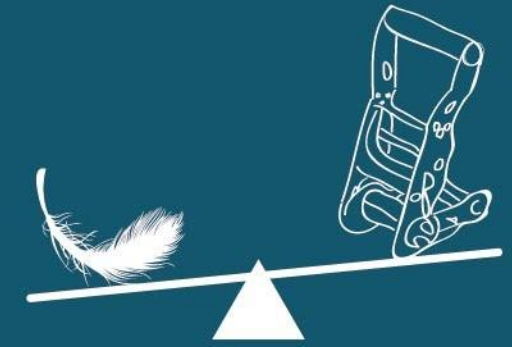

**2" Stainless Long Lever Ratchet Bukcle**  
**RBS51L-001**

Size: 2"/50mm  
B.S: 3000kg  
SUS 304 / SUS 316  
Long lever type  
Aluminum grip



**2" Stainless Ratchet Bukcle**  
**RBS51M-001**

Size: 2"/50mm  
B.S: 3000kg  
SUS 304 / SUS 316  
Middle handle type  
Aluminum grip



**1.5" Long Handle Stainless Ratchet Bukcle**  
**RBS43L-001**

Size: 1.5"/35mm  
B.S: 1500kg  
SUS 304 / SUS 316  
Long handle type  
Aluminum grip



**1.5" Middle Handle Stainless Ratchet Bukcle**  
**RBS43M-001**

Size: 1.5"/35mm  
B.S: 1500kg  
SUS 304 / SUS 316  
Middle handle type  
Aluminum grip



**1.5" Short Handle Stainless Ratchet Bukcle**  
**RBS43S-002**

Size: 1.5"/35mm  
B.S: 1500kg  
SUS 304 / SUS 316  
Short handle type  
Aluminum grip



**1.5" Light Duty Stainless Ratchet Bukcle**  
**RBS38-001**

Size: 1.5"/35mm  
B.S: 1200kg  
SUS 304 / SUS 316  
Middle handle type  
Aluminum grip



**1" Stainless Ratchet Bukcle**  
**RBS28-001**

Size: 1"/25mm  
B.S: 600kg  
SUS 304 / SUS 316  
Middle handle type  
Aluminum grip



**1" Light Duty Stainless Ratchet Bukcle**  
**RBS24-001**

Size: 1"/25mm  
B.S: 400kg  
SUS 304 / SUS 316



**2" Aluminum Ratchet Bukcle**  
**RBA51-001**

Size: 2"/50mm  
B.S: 900kg  
Finish: Anodized  
Short handle type



**1.5" Aluminum Ratchet Bukcle**  
**RBA38-001**

Size: 1.5"/35mm  
B.S: 800kg  
Finish: Anodized  
Middle handle type



**1" Aluminum Ratchet Bukcle**  
**RBA24-001**

Size: 1"/25mm  
B.S: 500kg  
Finish: Anodized

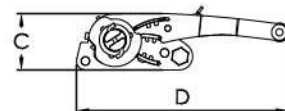
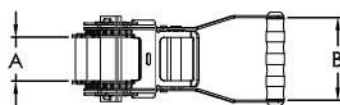
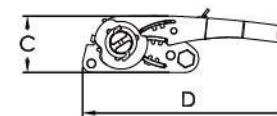
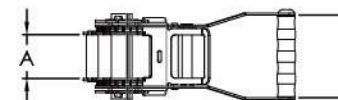

Item No.	A mm	B mm	C mm	D mm
RBS51L-001	56	98	56	229
RBS51M-001	56	98	60	197
RBS43L-001	41	80	56	170
RBS43M-001	41	56	56	235
RBS43S-002	41	56	58	153
RBS38-001	40	66	40	134
RBS28-001	31	57	37	131
RBS24-001	27	38	41	110

Item No.	A mm	B mm	C mm	D mm
RBA51-001	54	79	40	131
RBA38-001	42	66	40	133
RBA24-001	27	38	41	110

## RATCHET BUCKLE

# Ergonomic Rubber Grip Series

Heavy duty load securing preferred.  
High visibility with colorful rubber handle.  
Side rubber caps for better protection.

Comfort  
Streamline Shape  
Fashion



## RATCHET BUCKLE

# Conjoined Hook Series

Exclusive conjoined hook end design.  
To replace webbing end and save cost.  
Ease to operate and maintain.  
All size available.



SIMPLE, EASIER AND COST DOWN



**2" Ergonomic Rubber Handle Ratchet Buckle**  
**RB51L-025**

Size: 2"/50mm  
B.S: 5000kg  
Finish: Zinc & Electric Black  
Long lever type  
Rubber grip



**2" Ergonomic Middle Handle Ratchet Buckle**  
**RB51M-015**

Size: 2"/50mm  
B.S: 5000kg  
Finish: Zinc & Electric Black  
Middle handle type  
Rubber grip



**1.5" Ergonomic Light Duty Ratchet Buckle**  
**RB38M-006**

Size: 1.5"/35 mm  
B.S: 1800kg  
Finish: Zinc & Electric Black  
Middle handle type  
Rubber grip



**1" Ergonomic Rubber Handle Ratchet Buckle**  
**RB28-008**

Size: 1"/25 mm  
B.S: 1200kg  
Finish: Zinc & Electric Black  
Middle handle type  
Rubber grip



**1" Ergonomic Light Duty Ratchet Buckle**  
**RB24-023**

Size: 1"/25 mm  
B.S: 800kg  
Finish: Zinc & Electric Black  
Rubber grip

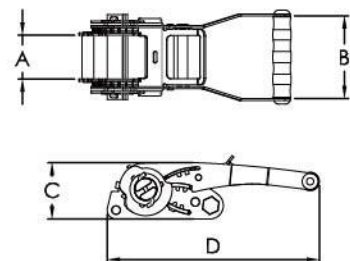

Item No.	A mm	B mm	C mm	D mm
RB51L-025	54	107	60	223
RB51M-015	54	107	54	205
RB38M-006	42	80	40	150
RB28-008	30	65	41	139
RB24-023	27	43	41	125



**2" Middle Handle Ratchet Buckle with conjoined hook**  
**RB51M-002C**

Size: 2"/50mm  
B.S: 5000kg  
Finish: Zinc & Electric Black  
Middle handle type  
Aluminum grip  
Exclusive hook end



**1.5" Middle Handle Ratchet Buckle with Conjoined hook**  
**RB43L-009C**

Size: 1.5"/35mm  
B.S: 3000kg  
Finish: Zinc & Electric Black  
Middle handle type  
Rotatable plastic grip  
Exclusive hook end



**1.5" Straight Handle Ratchet Buckle with Conjoined hook**  
**RB43M-003C**

Size: 1.5"/35mm  
B.S: 3000kg  
Finish: Zinc & Electric Black  
Straight handle type  
Aluminum grip  
Exclusive hook end



**1.5" Rubber Handle Ratchet Buckle with Conjoined hook**  
**RB38M-007C**

Size: 1.5"/35mm  
B.S: 2000kg  
Finish: Zinc & Electric Black  
Middle type  
Rubber grip  
Exclusive hook end



**1" Middle Handle Ratchet Buckle with conjoined hook**  
**RB28-005C**

Size: 1"/25mm  
B.S: 1200kg  
Finish: Zinc & Electric Black  
Middle handle type  
Aluminum grip  
Exclusive hook end



**1" Once Forming Frame Ratchet Buckle with conjoined hook**  
**RB28-024C**

Size: 1"/25mm  
B.S: 1200kg  
Finish: Zinc & Electric Black  
Handle and side panel once forming type  
Exclusive hook end



**1" Light Duty Ratchet Buckle with conjoined hook**  
**RB24-020C**

Size: 1"/25mm  
B.S: 800kg  
Finish: Yellow Zinc & Electric Black  
Handle and side panel once forming type  
Exclusive hook end

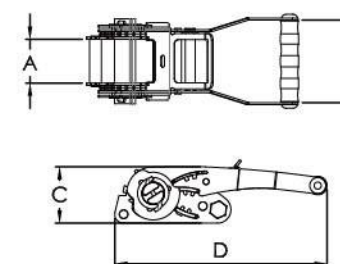

Item No.	A mm	B mm	C mm	D mm
RB51M-002C	56	98	60	271
RB43L-009C	41	80	56	235
RB43M-003C	41	56	56	235
RB38M-007C	42	80	40	190
RB28-005C	31	57	37	218
RB28-024C	30	59	41	173
RB24-020C	27	38	42	170

# RATCHET BUCKLE

## Traditional Series

Support various cargo control system.



**3" Long Handle Ratchet Buckle**  
**RB76-001**

Size: 3"/75mm  
B.S: 10000kg  
Finish: Yellow Zinc  
Long handle type  
Aluminium grip



**2" Long Handle Ratchet Buckle**  
**RB51L-008**

Size: 2"/50mm  
B.S: 5000kg  
Finish: Yellow Zinc  
Long handle type  
Aluminium grip



**2" Economic Type Ratchet Buckle**  
**RB51L1-010**

Size: 2"/50mm  
B.S: 3000kg  
Finish: Yellow Zinc  
Long handle type  
Plastic grip  
U-pin end



**2" Long Handle Ratchet Buckle**  
**RB51L-010**

Size: 2"/50mm  
B.S: 5000kg  
Finish: Yellow Zinc & Electric Black  
Long handle type  
Plastic grip



**2" Middle Handle Ratchet Buckle**  
**RB51M-001**

Size: 2"/50mm  
B.S: 5000kg  
Finish: Yellow Zinc  
Middle handle type  
Aluminium grip



**2" Straight Handle Ratchet Buckle**  
**RB51N-001**

Size: 2"/50mm  
B.S: 5000kg  
Finish: Yellow Zinc  
Straight handle type  
Aluminium grip



**2" Light Duty Ratchet Buckle**  
**RB51S-003**

Size: 2"/50mm  
B.S: 2000kg  
Finish: Zinc & Electric Black  
Short handle type  
Aluminium grip



**1.5" Long Handle Ratchet Buckle**  
**RB43L-001**

Size: 1.5"/35mm  
B.S: 3000kg  
Finish: Yellow Zinc  
Long handle type  
Aluminium grip



**1.5" Straight Handle Ratchet Buckle**  
**RB43S-007**

Size: 1.5"/35mm  
B.S: 3000kg  
Finish: Zinc & Electric Black  
Long handle type  
Aluminium grip



**1.5" Light Duty Ratchet Buckle**  
**RB38M-011**

Size: 1.5"/35mm  
B.S: 1800kg  
Finish: Zinc & Electric Black  
Middle handle type  
Aluminium grip



**1" Once Forming Frame Ratchet Buckle**  
**RB28-010**

Size: 1"/25mm  
B.S: 1200kg  
Finish: Yellow Zinc  
Handle and side panel once forming type



**1" Middle Handle Ratchet Buckle**  
**RB28-023**

Size: 1"/25mm  
B.S: 1200kg  
Finish: Zinc  
Aluminium grip



**1" Light Duty Ratchet Buckle**  
**RB24-020**

Size: 1"/25mm  
B.S: 800kg  
Finish: Yellow Zinc & Electric Black



**3/4" Mini Ratchet Buckle**  
**RB18-001**

Size: 3/4"/15mm  
B.S: 300kg  
Finish: Zinc & Electric Black



**1/2" Mini Ratchet Buckle**  
**RB13-001**

Size: 1/2"/10mm  
B.S: 100kg  
Finish: Zinc & Electric Black

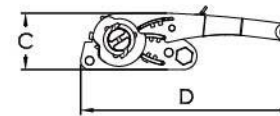
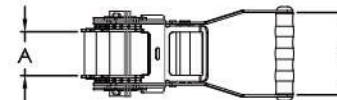

Item No.	A mm	B mm	C mm	D mm
RB76-001	80	112	77	320
RB51L-008	56	98	56	229
RB51L1-010	52	98	56	230
RB51L-010	56	98	56	229
RB51M-001	56	98	60	197
RB51N-001	56	70	58	170
RB51S-003	54	79	40	131
RB43L-001	41	80	56	170
RB43S-007	41	56	58	153
RB38M-011	42	66	40	133
RB28-010	30	59	41	118
RB28-023	31	57	37	131
RB24-020	27	38	41	110
RB18-001	20	29	30	92
RB13-001	15	24	30	83



# Multi-function Super Ratchet Buckle

# Roller Chain Binder

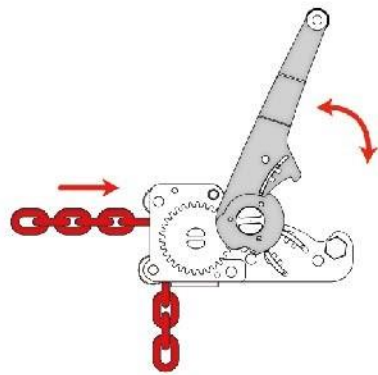

CHAIN

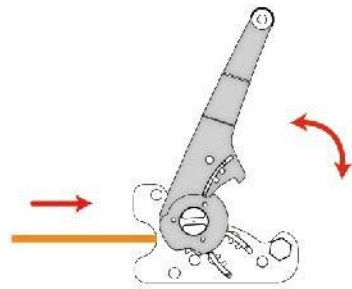

WEBBING



DETACHABLE



RATCHET TIE DOWN WITH A.B.S SYSTEM

## Multi-function Super Ratchet Buckle (3 IN 1)

### RLB-ABS-01

Size: 2"/50mm  
 B.S: 2000kg  
 Finish: Zinc & Electric Black  
 Built-in A.B.S system  
 Removable Lever Block  
 Standard Ratchet Buckle

## 2T Roller Chain Binder

### RCRB-001

Size: 5/8"  
 0.75T Swivel Forged hook ends  
 Includes of 90cm 2T Chain  
 N.W.: 3.60 KG  
 W.L.L: 750 KG  
 B.S: 2250 KG  
 PAWL Safety Lock  
 Quick ratchet design is easy to tension and release.



## 0.5T Roller Chain Binder

### RCRB-003

Size: 3/8"  
 1/4T Swivel Forged hook ends  
 Includes of 90cm 0.5T Chain  
 N.W.: 1.38 KG  
 W.L.L: 250 KG  
 B.S: 750 KG  
 PAWL Safety Lock  
 Quick ratchet design is easy to tension and release.



## 1T Roller Chain Binder

### RCRB-002

Size: 1/2"  
 0.5T Swivel Forged hook ends  
 Includes of 90cm 1T Chain  
 N.W.: 2.27 KG  
 W.L.L: 500 KG  
 B.S: 1500 KG  
 PAWL Safety Lock  
 Quick ratchet design is easy to tension and release.

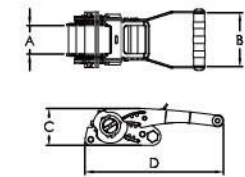

Item No.	A mm	B mm	C mm	D mm
RCRB-001	-	98	72	330
RCRB-002	-	81	64	230
RCRB-003	-	66	52	190

# Ratchet Load Binder

# Chain Binder

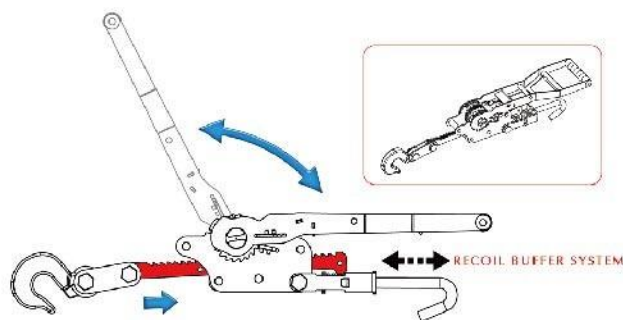

## 2" Multi-function Ratchet Load Binder

### RLB-A-001

Size: 2"/50mm  
 B.S: 4000kg  
 Finish: Zinc & Electric Black  
 Built-in recoil buffer system  
 Plastic grip  
 Forged hook in black plated

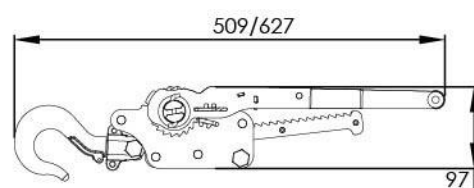
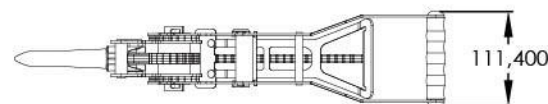

## 2T Chain Ratchet Buckle

### CRB-001

Size: 7mm  
 0.75T Swivel Forged hook ends  
 Includes of 152cm 2T Chain  
 N.W.: 4.76 KG  
 W.L.L: 750 KG  
 B.S: 2250 KG  
 PAWL Safety Lock  
 Quick ratchet design is easy to tension and release.



## 1T Chain Ratchet Buckle

### CRB-002

Size: 5mm  
 0.5T Swivel Forged hook ends  
 Includes of 130cm 1T Chain  
 N.W.: 2.68 KG  
 W.L.L: 500 KG  
 B.S: 1500 KG  
 PAWL Safety Lock  
 Quick ratchet design is easy to tension and release.

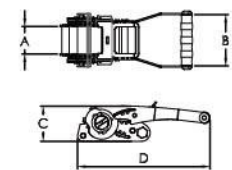

Item No.	A mm	B mm	C mm	D mm
CRB-001	-	98	72	330
CRB-002	-	81	64	230
CRB-003	-	66	52	190

## 0.5T Chain Ratchet Buckle

### CRB-003

Size: 4mm  
 1/4T Swivel Forged hook ends  
 Includes of 124cm 0.5T Chain  
 N.W.: 1.82 KG  
 W.L.L: 250 KG  
 B.S: 750 KG  
 PAWL Safety Lock  
 Quick ratchet design is easy to tension and release.



# Ratchet Tie Down



**2" Detachable Ratchet Tie Down**  
**RTD51B-T2**  
 Size: 2"/50mm  
 B.S: 5000kg  
 Finish: Zinc & Electric Black  
 Removable Handle  
 Plastic grip  
 Includes of 8M weather-resistant Polyester webbing  
 Double J hook ends  
 \*EN 12195-2:2000 certified



Removable Handle



Rotatable Wave Rubber Grip



Patented Gear Structure



1 to 2 Blister Retail Package



**2" A.B.S Ratchet Tie Down**  
**RTD51R-001**  
 Size: 2"/50mm  
 B.S: 5000kg  
 Finish: Zinc & Electric Black  
 Built-in A.B.S system  
 Plastic grip  
 Includes of 8M weather-resistant Polyester webbing  
 Double J hook ends



**2" Extendable Handle Ratchet Tie Down**  
**RTD51E-003**  
 Size: 2"/50mm  
 B.S: 5000kg  
 Finish: Zinc & Electric Black  
 Extendable handle type  
 Includes of 8M weather-resistant Polyester webbing  
 Double J hook ends  
 \*EN 12195-2:2000 certified



**2" Standard Long Handle Ratchet Tie Down**  
**RTD51L-025**  
 Size: 2"/50mm  
 B.S: 5000kg  
 Finish: Yellow Zinc  
 Long handle type  
 Aluminium grip  
 Includes of 8M weather-resistant Polyester webbing  
 Double J hook ends  
 \*EN 12195-2:2000 certified



**2" Standard Long Handle Ratchet Tie Down**  
**RTD51L-008**  
 Size: 2"/50mm  
 B.S: 5000kg  
 Finish: Yellow Zinc  
 Long handle type  
 Plastic grip  
 Includes of 8M weather-resistant Polyester webbing  
 Double J hook ends  
 \*EN 12195-2:2000 certified



**2" Middle Handle Ratchet Tie Down**  
**RTD51M-006**  
 Size: 2"/50mm  
 B.S: 5000kg  
 Finish: Yellow Zinc  
 Middle handle type  
 Aluminium grip  
 Includes of 8M weather-resistant Polyester webbing  
 Double J hook ends  
 \*EN 12195-2:2000 certified



**2" Straight Handle Ratchet Tie Down**  
**RTD51N-002**  
 Size: 2"/50mm  
 B.S: 5000kg  
 Finish: Yellow Zinc  
 Straight handle type  
 Aluminum grip  
 Includes of 8M weather-resistant Polyester webbing  
 Double J hook ends



**2" Light Duty Ratchet Tie Down**  
**RTD51S-003**  
 Size: 2"/50mm  
 B.S: 2000kg  
 Finish: Yellow Zinc  
 Short handle type  
 Steel grip  
 Includes of 8M weather-resistant Polyester webbing  
 Double J hook ends



**1.5" Long Handle Ratchet Tie Down**  
**RTD43L-001**  
 Size: 1.5"/35mm  
 B.S: 3000kg  
 Finish: Yellow Zinc  
 Long handle type  
 Aluminum grip  
 Includes of 4.5M weather-resistant Polyester webbing  
 Double J hook ends



**1.5" Middle Handle Ratchet Tie Down**  
**RTD43M-001**  
 Size: 1.5"/35mm  
 B.S: 3000kg  
 Finish: Yellow Zinc  
 Middle handle type  
 Aluminum grip  
 Includes of 4.5M weather-resistant Polyester webbing  
 Double J hook ends



**1.5" Short Handle Ratchet Tie Down**  
**RTD43S-001**  
 Size: 1.5"/35mm  
 B.S: 3000kg  
 Finish: Yellow Zinc  
 Short handle type  
 Aluminum grip  
 Includes of 4.5M weather-resistant Polyester webbing  
 Double J hook ends  
 \*EN 12195-2:2000 certified



**1" Middle Handle Ratchet Tie Down**  
**RTD28-001**  
 Size: 1"/25mm  
 B.S: 1200kg  
 Finish: Yellow Zinc  
 Middle handle type  
 Aluminum grip  
 Includes of 4M weather-resistant Polyester webbing  
 Double J hook ends  
 \*EN 12195-2:2000 certified



**1" Once Forming Frame Ratchet Tie Down**  
**RTD28-002**  
 Size: 1"/25mm  
 B.S: 1200kg  
 Finish: Yellow Zinc  
 Handle and side panel once forming type  
 Includes of 4M weather-resistant Polyester webbing  
 Double J hook ends



**1" Light Duty Ratchet Tie Down**  
**RTD24-001**  
 Size: 1"/25mm  
 B.S: 800kg  
 Finish: Yellow Zinc  
 Includes of 4M weather-resistant Polyester webbing  
 Double J hook ends



**3/4" Mini Ratchet Tie Down**  
**RTD18-001**  
 Size: 3/4"/15mm  
 B.S: 300kg  
 Finish: Zinc & Electric Black  
 Includes of 2M weather-resistant Polyester webbing  
 S hook ends



**1/2" Mini Ratchet Tie Down**  
**RTD13-001**  
 Size: 1/2"/10mm  
 B.S: 100kg  
 Finish: Zinc & Electric Black  
 Includes of 2M weather-resistant Polyester webbing  
 S hook ends

# Stamping Parts

Precision Punching Machine

PRECISION PUNCHING MACHINING



Flat hook-01  
FTH-001

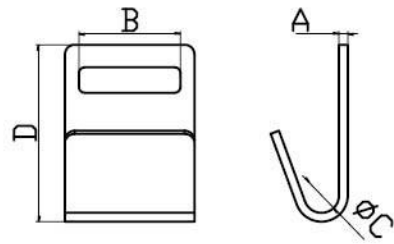

Item No.	A mm	B mm	C mm	W.L.L (kg)
F01D-025025052	25	52	2.5	1000
F01D-051045092	51	92	4.5	5000

\*W.L.L=Working Load Limit



Flat hook-02  
FTH-002

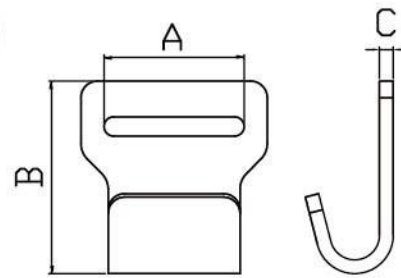

Item No.	A mm	B mm	C mm	W.L.L (kg)
F01D-031023029	31	29	2.3	500
F01D-040050065	40	75	5	1500
F01D-051050070	51	70	5	4000

\*W.L.L=Working Load Limit



Twist Snap Hook  
FTH-003

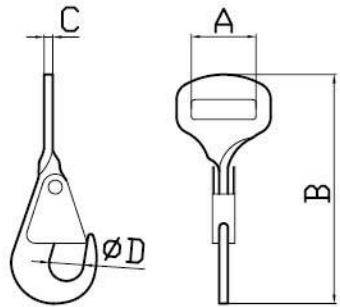

Item No.	A mm	B mm	C mm	D mm	W.L.L (kg)
FR66P-038050132	38	132	5	20	3000
FR66P-050060155	50	155	6	24	5000

\*W.L.L=Working Load Limit



2" Delta Flat Hook  
FTH-004

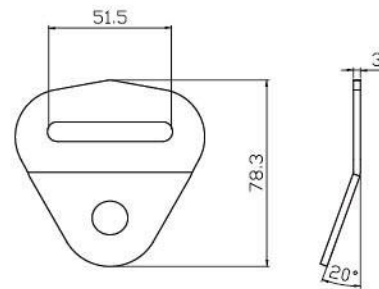

Stamped Buckle-01  
STP-001

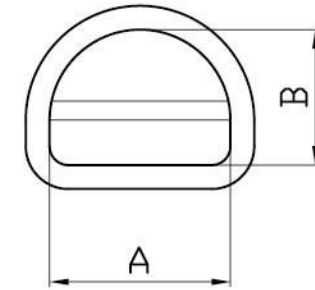

Item No.	A mm	B mm
FH44-061050062	45	45
FH44-06930542	54	54



Stamped Buckle-02  
STP-002

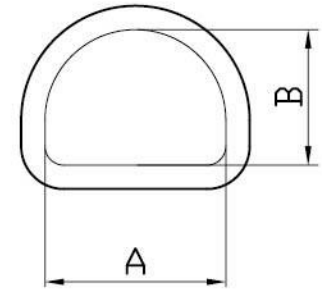

Item No.	A mm	B mm
FH44-0610562	45	45
FH44-06200478	47	33
FH44-0685068	49	48.5



Stamped Buckle-03  
STP-003

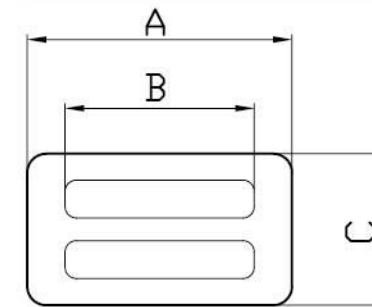

Item No.	A mm	B mm	C mm
FH44-0473028022	47.3	38.2	22
FH44-0500280380	49	38	38
FH44-060040030	60	46	30



Stamped Buckle-04  
STP-004

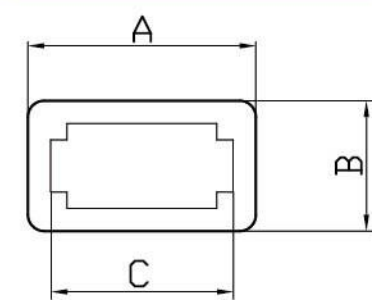

Item No.	A mm	B mm	C mm
FH44-063042	63	45	42
FH44-075045	75	53	45

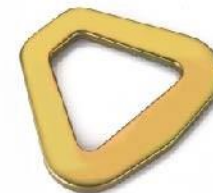

Stamped Buckle-05  
STP-005

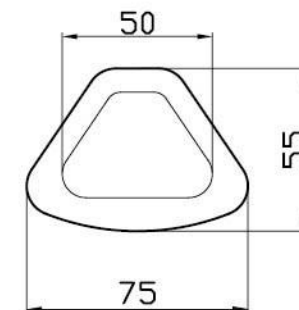

# Ring

Practised molding team & precision punching machining  
Your best partner for OEM/ODM project



SPEEDY & STABLE

TIME IS MONEY! AUTOMATIC WIRE FORMING MACHINE  
PROVIDED QUICK DELIVERY

# Buckle



D Ring  
RING-01



D Ring with tube  
RING-02

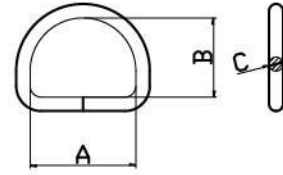

Item No.	A mm	B mm	C mm	B.S (kg)
RD04-025047030	25	30	4.7	1500
RD04-025063032	25	32	6.3	1500
RD04-044063042	44	4	6.3	1800

Item No.	A mm	B mm	C mm	B.S (kg)
RD04-050080060	50	60	8	2300
RD04-051063047	51	47	6.3	2300



Wire Buckle  
BW01

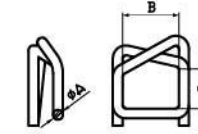

Item No.	A mm	B mm	C mm	W.L.L (1bs)
BW01-009030019	3	19	9	480
BW01-013030019	3	19	13	480
BW01-016030025	3	25	16	680
BW01-016040025	4	25	16	680
BW01-019040025	4	25	19	930
BW01-019050025	5	25	19	950
BW01-027060027	6	27	27	1800
BW01-030070035	7	35	30	2500

\*W.L.L=Working Load Limit



Lap Link  
LK01

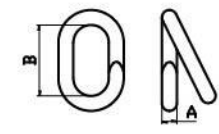

Item No.	A mm	B mm	Item No.	A mm	B mm
L01-035019	35	19	L01-063051	63	51
L01-040019	40	19	L01-080038	80	38
L01-050025	50	25	L01-095051	95	51
L01-060032	60	32	L01-120064	120	64
L01-060038	60	38			



Waisted Ring  
RING-03

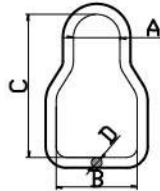

Item No.	A mm	B mm	C mm	D mm
WH08-050026042	11	26	42	5
WH08-063028061	22	28	61	6.3



O Ring  
RING-04

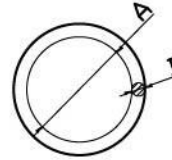

Item No.	A mm	B mm	Item No.	A mm	B mm
RO01-015030	15	3	RO01-035050	35	5
RO01-019030	19	3	RO01-038060	38	6
RO01-020040	20	4	RO01-040040	40	4
RO01-025040	25	4	RO01-050080	50	8
RO01-025050	25	5	RO01-055060	55	6
RO01-028050	28	5	RO01-065090	65	9
RO01-030050	30	5	RO01-076080	76	8



Eye Buckle/One Way Buckle  
RR02

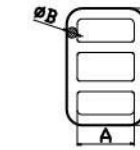

Item No.	A mm	B mm	C mm
RR02-045110110	45	11	110
RR02-055110115	55	11	115



Rave Hook  
WH03

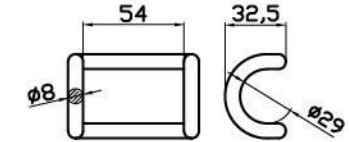

Triangle Ring  
RING-05

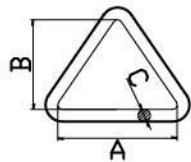

Item No.	A mm	B mm	C mm	B.S (kg)
RD05-026060034	26	34	6	1000
RD05-053063045	53	44.5	6.3	2200
RD05-050110048	50	48	11	3800
RD05-068011050	68	50	11	5000
RD05-070080062	70	62	8	-



Oval Ring  
RING-06

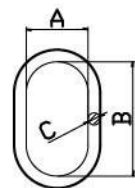

Item No.	A mm	B mm	C mm
RA01-008050025	8	28	5
RA01-013050051	13	51	5
RA01-013080605	13	60.5	8
RA01-030115051	30	51	11.5



Adjuster Buckle  
Buckle-01  
SUS 304

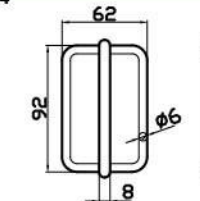

Buckle with Dual Anti-slip Adjuster  
Buckle-03  
SUS 304

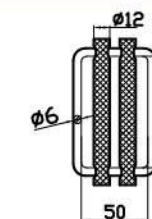

Buckle with Anti-slip Adjuster  
Buckle-02

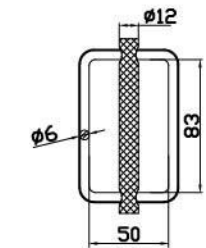

Tongue Buckle  
Buckle-04

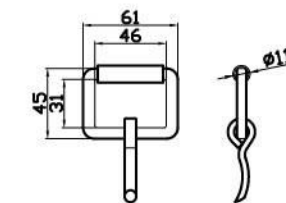

Rectangle Ring  
RING-07



Item No.	A mm	B mm	C mm	Item No.	A mm	B mm	C mm
RR01-0127025095	12.7	9.5	2.5	RR01-025032051	50.8	25.4	3.2
RR01-019030095	19	9.5	3	RR01-051040020	51	20	4
RR01-022040040	22	40	4	RR01-051050010	51	10	4
RR01-025020065	25	6.5	2	RR01-051060032	51	32	6
RR01-038030095	38	9.5	3	RR01-070050025	70	25	5

# Hook



Bungee Hook-01  
**SPR02**  
SUS304

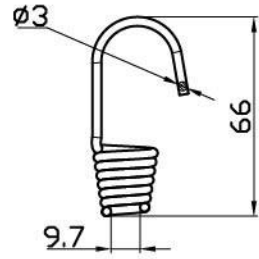

Bungee Hook-02  
**SPR03**  
SUS304

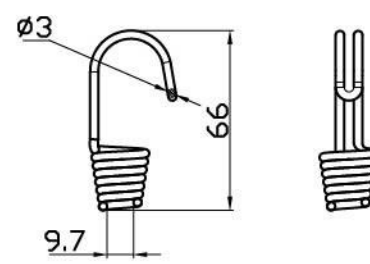

Snap Hook  
**SH04P**

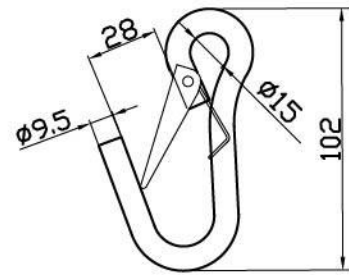

J Shaped Tie Hook  
**J16-060060Z**

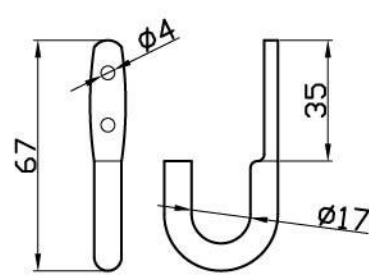

Spring Hook  
**WH08P**

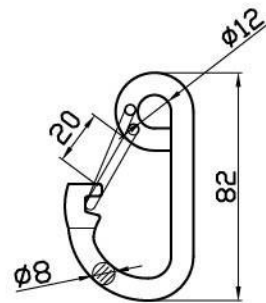

Spring Hook  
**SPRING HOOK-01**

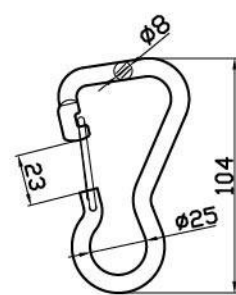

Spring Hook  
**SPRING HOOK-02**

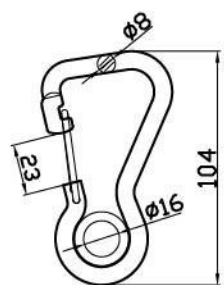

Spring Hook  
**SPRING HOOK-03**

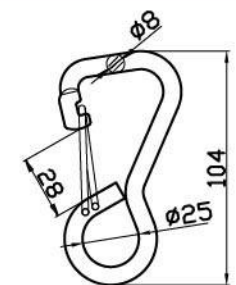

Snap Hook with Eyelet  
**SNAP HOOK-01**

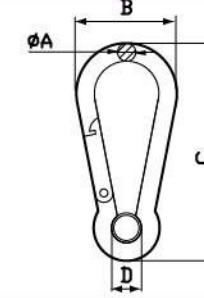

Item No.	A mm	B mm	C mm	D mm	Open mm	W.L.L (lbs)
SH01X-040040	4	20	40	5	7	80
SH01X-050050	5	25	50	5	7	100
SH01X-060060	6	30	60	5	8	140
SH01X-070070	7	35	70	7	8	200
SH01X-080080	8	40	80	10	9	250
SH01X-090090	9	45	90	10	10	280
SH01X-100100	10	50	100	13	11	400
SH01X-110120	11	527	120	13	16	500
SH01X-120140	12	67	140	15	19	600
SH01X-130160	13	74	160	17	25	700
SH01X-140180	14	86	180	17	35	900

\*W.L.L=Working Load Limit



Snap Hook  
**SNAP HOOK-02**

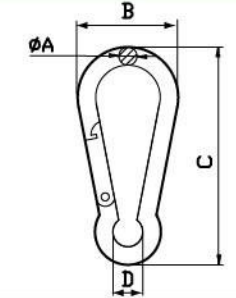

Item No.	A mm	B mm	C mm	D mm	Open mm	W.L.L (lbs)
SH01-040040	4	20	40	5	7	80
SH01-050050	5	25	50	5	7	100
SH01-060060	6	30	60	5	8	140
SH01-070070	7	35	70	7	8	200
SH01-080080	8	40	80	10	9	250
SH01-090090	9	45	90	10	10	280
SH01-100100	10	50	100	13	11	400
SH01-110120	11	527	120	13	16	500
SH01-120140	12	67	140	15	19	600
SH01-130160	13	74	160	17	25	700
SH01-140180	14	86	180	17	35	900

\*W.L.L=Working Load Limit



Quick Link  
**LQ01**

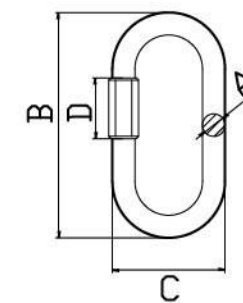

Item No.	A mm	B mm	C mm	D mm	W.L.L (lbs)
LQ01-017050036	3.5	36.5	17	5	175
LQ01-019055040	4	40	19.5	5.5	500
LQ01-023050048	5	49	23	6.5	650
LQ01-026060057	6	58	26.5	7.5	875
LQ01-030070065	7	65	30.5	8.5	1200
LQ01-034080076	8	75	33.5	10.5	1525
LQ01-035090082	9	82	35	11.5	1975
LQ01-040100090	10	90	40.5	12.5	2300
LQ01-047120107	12	107	47.5	14.5	2500
LQ01-054140125	14	125	54.5	17	2800

\*W.L.L=Working Load Limit

# J Hook



Double J hook - Zinc  
J-Hook-01

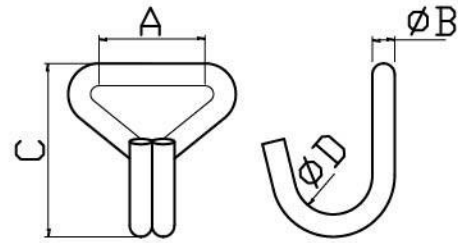

Double J hook - Yellow Zinc  
J-Hook-02



Double J hook - PVC Black  
J-Hook-03



Double J hook - Matt Yellow Zinc  
J-Hook-04



Stainless Double J hook  
J-Hook-05  
SUS 304/SUS 316

Item No.	A mm	B mm	C mm	D mm	B.S (kg)
J01-015047042SP	15	4.7	42	-	200
J01-025047042SP	25	4.7	42	9	500
J01-025047063SP	25	4.7	63	13	900
J01-025060047SP	25	6	47	10	1000
J01-025063047SP	25	6.3	47	10	1650
J01-025063050SP	25	6.3	50	9	1800
J01-025070060SP	25	7	60	20	1800

Item No.	A mm	B mm	C mm	D mm	B.S (kg)
J01-015047042	15	4.7	42	-	200
J01-025047063	25	4.7	63	13	900
J01-025063047	25	6.3	47	10	1650
J01-025070060	25	7	60	20	1800
J01-027070054	27	7	54	26.5	1400
J01-025080080	28	8	80	20	1800
J01-030063050	30	6.3	50	10	1360
J01-038090088	38	9	88	20	3300
J01-051050063	51	3	35	6	300
J01-051080054	51	8	54	20	2000
J01-051090085	51	9	85	20	2000
J01-051095085	51	9.5	85	20	3500
J01-051110085	51	11	85	23	4300
J01-051110106	51	11	106	23	4500
J01-051115085	51	11.5	85	23	5000
J01-051120085	51	12	85	23	5000
J01-051122103	51	12.2	103	23	5000
J01-076160121	76	16	121	20	10000
J01-076160135	76	16	135	20	10000
J01-076160140	76	16	140	20	10000
J01-101160143	101	16	143	20	10000



Finger Profile Hook  
J-Hook-06

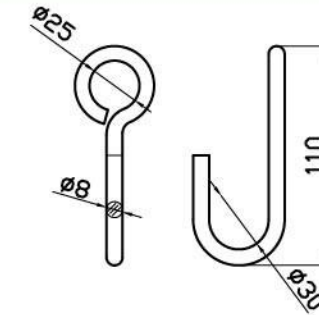

Welding Tube Profile Hook  
J-Hook-08

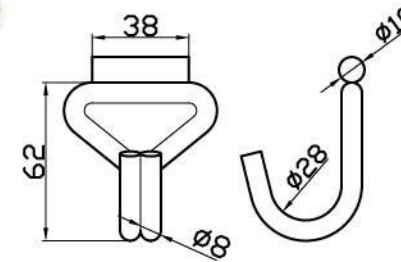

J Hook  
J-Hook-10

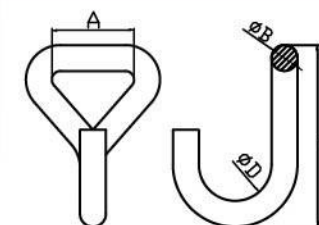

Item No.	A mm	B mm	C mm	D mm	B.S (kg)
J04-038120090	38	12	90	20	3000
J04-0475150105	47.5	15	105	20	5000
J04-051150130	51	15	130	15	5000



Welding Tube Single Hook  
J-Hook-07

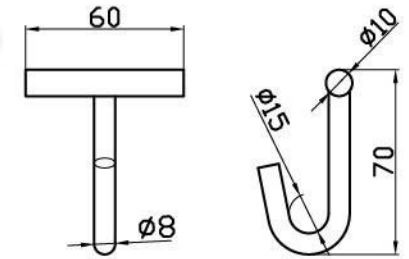

Eye Hook  
J-Hook-09

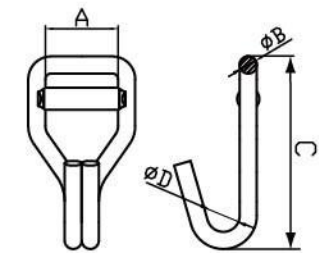

Item No.	A mm	B mm	C mm	D mm	B.S (kg)
J11-038095115	38	9.5	115	-	3000
J11-050120137	50	12	137	23	5000



Hook and Keeper  
J-Hook-11

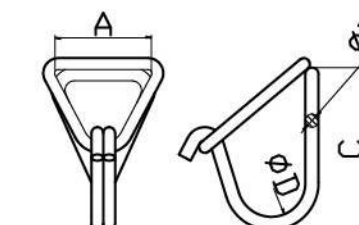

Item No.	A mm	B mm	C mm	D mm	B.S (kg)
J07R-038070086Y	38	7	86	20	2000
J07R-051085105Y	51	8	105	40	5000

# S Hook



S Hook  
S HOOK-01

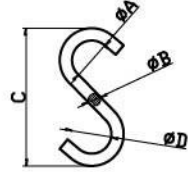

Item No.	A mm	B mm	C mm	D mm
S06-009025028	12	2.5	28	12
S06-011050039	12	5	39	12
S06-016050056	14	5	56	14
S06-018062062	18	6.2	62	18
S06-022095082	23	9.5	82	23
S06-035040085	34.5	4	85	34.5



S Hook - PE Black coating  
S HOOK-03



S Hook - PVC Black coating  
S HOOK-03

Item No.	A mm	B mm	C mm	D mm	B.S (kg)
S01-025070104	25	7	104	26	750
S01-025080105	25	8	105	26	900
S01-025080118	25	8	118	30	900
S01-025090110	25	9	110	25	900
S01-025105122	25	10.5	122	28	1500
S01-027295119	27	9.5	119	27	1200
S01-027100122	27	10	122	33	1500
S01-030130148	30	13	148	-	2500



S Hook with Spring  
S HOOK-04

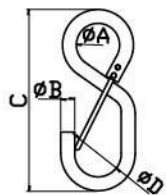

S Hook  
S HOOK-02

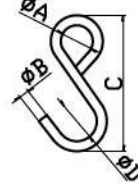

Item No.	A mm	B mm	C mm	D mm
S03-008030027	8	3	27	-
S03-010030035	10	3	35	-
S03-016050068	16	5	68	-
S03-018055072	18	5.5	72	-
S03-022080083	22	8	83	25
S03-022080090	22	8	90.5	28
S03-023073089	23	7.3	89	27
S03-025100099	25	10	99	31



S Hook - PVC Blue coating  
S HOOK-03

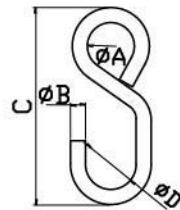

Item No.	A mm	B mm	C mm	D mm	B.S (kg)
S01-025070104SP	25	17	104	26	250
S01-025080105SP	25	8	105	26	250
S01-025090110SP	25	9	110	25	450
S01-025130130SP	25	13	130	29	1900
S01-027095119SP	27	9.5	119	27	750

\*SUS 304/SUS 316

Item No.	A mm	B mm	C mm	D mm
S01P-025080105	25	8	105	26
S01P-025080119	25	8	119	26
S01P-027095119	27	9.5	119	27
S01P-031080113	31	8	113.5	26

# Bolt

Bolt/Stud  
Bolt-01

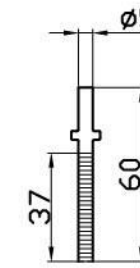

Bolt/Eyelet Screw  
Bolt-02

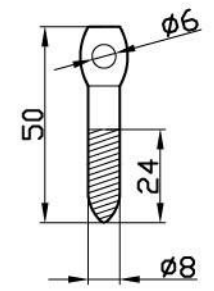

Bolt/Eyelet Stud  
Bolt-03

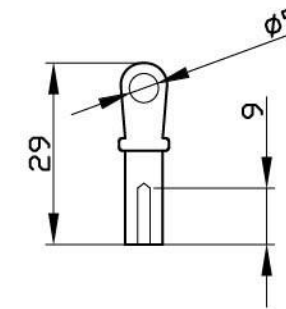

Bolt/Eyelet Stud  
Bolt-04

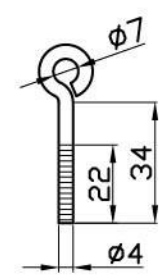

Bolt/Stud Hook  
Bolt-05

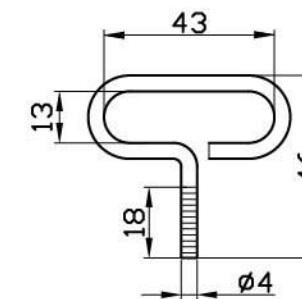

# Fitting

# Forging

Cold Forming and Cold Forging Parts  
 Building, Auto Parts, Marine Accessories  
 PPAP (Production Part Approval Process)  
 IMDS (International Material Data System)  
 Customization/ Please send your spec. or drawing to us.

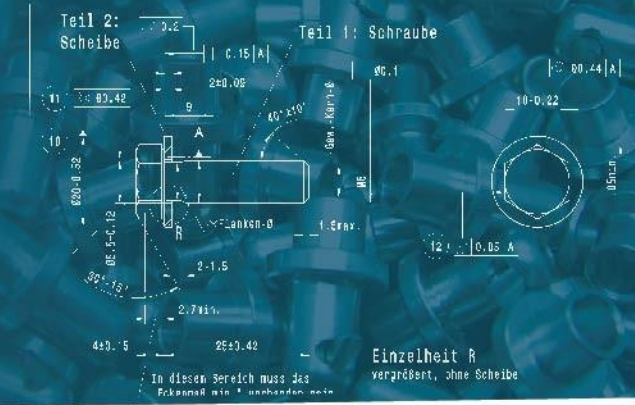

**Double Stud Fitting**  
**SF202P-062018025**  
 B.S: 2300kg  
 Finish: Zinc

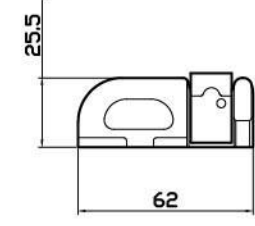

**Double Stud Fitting with O ring**  
**SF202-062018025TZ-O**  
 B.S: 2300kg  
 Finish: Zinc

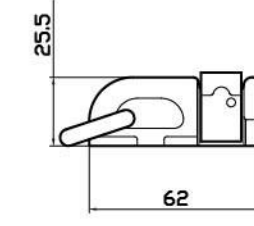

**End Fitting**  
**EF101-051YY**  
 B.S: 2300kg  
 Finish: Yellow Zinc

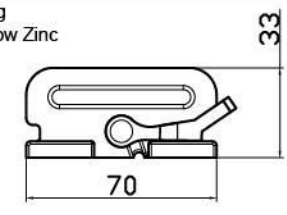

**Forged End Fitting**  
**EF103-02540127061Y**  
 B.S: 2300kg  
 Finish: Yellow Zinc

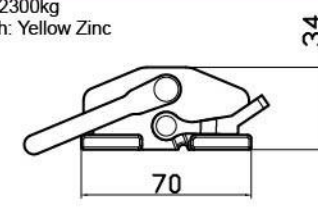

**Single Stud Fitting**  
**SF102P-0286050**  
 B.S: 1300kg  
 Finish: Anodized

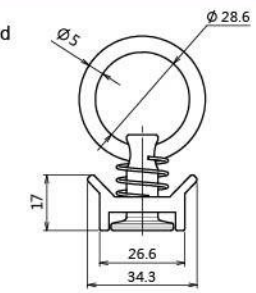

### FORGING-PART01

Customization / Please send your spec. or drawing to us.  
 \*Bush  
 \*Fastener  
 \*Rivet  
 Material(\*Options): Alloy Steel/ \*Aluminum/ \*Stainless Steel  
 Surface Treatment(\*Options): Zinc/ \*Yellow Zinc/ \*Nickel Plating/ \*Chromium Plating



### FORGING-PART02

Customization/ Please send your spec. or drawing to us.  
 \*Bush  
 \*Metal Hardware  
 \*Bracket  
 Material(\*Options): Alloy Steel/ \*Aluminum/ \*Stainless Steel  
 Surface Treatment(\*Options): Zinc/ \*Yellow Zinc/ \*Nickel Plating/ \*Chromium Plating



### FORGING-PART03

Customization/ Please send your spec. or drawing to us.  
 \*Collar  
 \*Eye Blot  
 \*Cap  
 Material(\*Options): Alloy Steel/ \*Aluminum/ \*Stainless Steel  
 Surface Treatment(\*Options): Zinc/ \*Yellow Zinc/ \*Nickel Plating/ \*Chromium Plating



### FORGING-PART04

Customization/ Please send your spec. or drawing to us.  
 \*Collar  
 \*Eye Blot  
 Material(\*Options): Alloy Steel/ \*Aluminum/ \*Stainless Steel  
 Surface Treatment(\*Options): Zinc/ \*Yellow Zinc/ \*Nickel Plating/ \*Chromium Plating



# Fall Protection



## TECHNOLOGY INFORMATION

STRICT QUALITY TEST METHOD AND LOADING TEST AT WIN CHANCE  
CARABINER & HOOKS

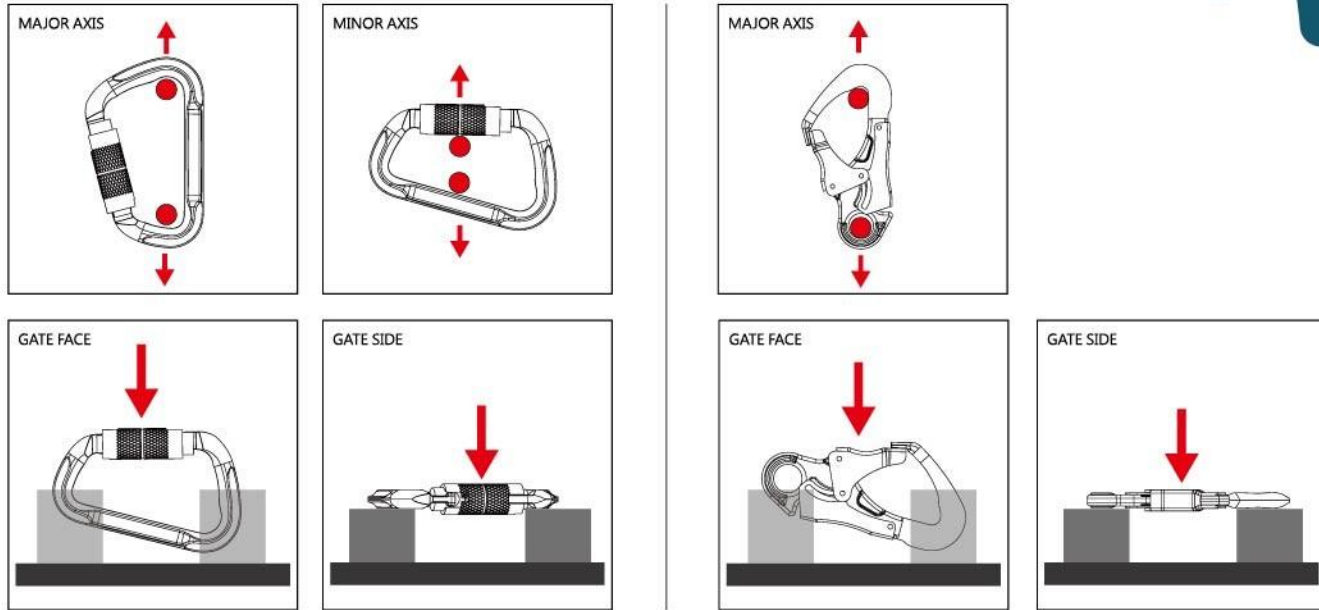

MINIMUM REQUIREMENTS AS OUTLINED FOR HOOKS AND CARABINERS PER SATNDRAD :

Standard	CSA Z259.12-01	CSA Z259.12-11	ANSI 359.1-1999	ANSI/ASSE Z359.12-2009	EN 362:2004	NFPA 1983-2006
Major Axis	5000 lbs (22.2kN)	5000 lbs (22.2kN)	5000 lbs (22.2kN)	5000 lbs (22.2kN)	4500 lbs (20kN)	***
Gate Face	220 lbs (1kN)	3600 lbs (16kN)	220 lbs (1kN)	3600 lbs (16kN)	220 lbs (1kN)	N/A
Side Load	350 lbs (1.55kN)	3600 lbs (16kN)	350 lbs (1.55kN)	3600 lbs (16kN)	350 lbs (1.55kN)	N/A
Minor Axis	N/A	3600 lbs (16kN)	N/A	3600 lbs (16kN)	**	***

\* New Standard require Minor Axis Loading for connectors with non-integral eyes.

\*\* EN: Basic Connector 1575 lbs(7kN); Multi Use Connector 3378lbs(15kN)

\*\*\* NFPA: Light Use... Major Axis gate closed 8922 lbs(39.7kN);  
Major Axis gate open 2473 lbs(11kN); Minor Axis 2473 lbs(11kN)

www.winchance.tw

## R&D TEAM



With current facilities, Win Chance already had professional production lines of steel alloy, stainless steel and aluminum alloy as our back up so we can achieve customer request on Carabiner, Safety Hooks, Safety Buckles and provided customer OEM and ODM items for their own design concept and meet their safety requirements. After 4 years striving in fall protection filed, we successfully gain worldwide customer trust and support customer produce various new functional demands with reliable quality. These fruitful results stepped up our aluminum forging production line to be built this January 2016, Win Chance now became a multiple supplier to offer more application for our business partner.

## WIN CHANCE DESIGN CONCEPT

### SHAPE

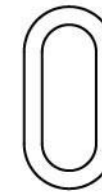

**OVAL**  
C Carabiner /  
Design for lower loads.

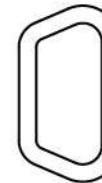

**Regular D**  
D Carabiner / Designed to  
orient the load in a  
predetermined direction on  
the connector's body.



**Asymmetrical D**  
V or D1 Carabiner / V Shape is  
offset or curved to one side allows  
a climber to use the Munter Hitch  
for belaying without the rope  
getting stuck or jammed.



**WAIST**  
Waist Carabiner is to design to  
secure rope at bottom. To make  
sure the loading force is in same  
horizontal.



**SPECIAL**  
Captive Eye Carabiner / Connectors  
with complex shapes for a  
particular purpose; to be connected  
directly to a special anchor type.

### GATE

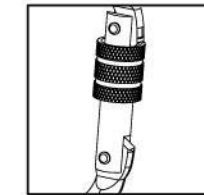

SCREW-LOCK

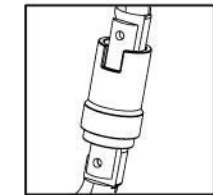

KWIK-LOCK

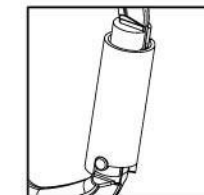

TRIPLE-LOCK

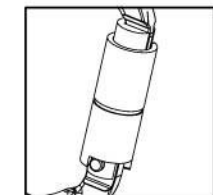

TWIST-LOCK

### NOSE

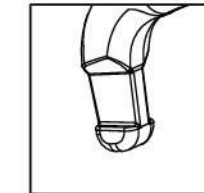

Snag Free

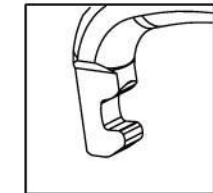

Regular

### CAPTIVE PIN

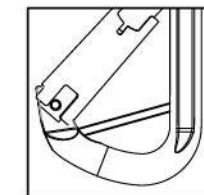

# Steel Carabiner



**C Carabiner**  
**CBR-S-003**

Min. Breaking Strength: 23kN/5000lbs  
Alloy Steel  
Screw Lock

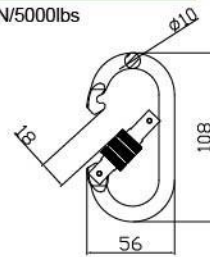

**C Carabiner**  
**CBR-S-005**

Min. Breaking Strength: 23kN/5000lbs  
Alloy Steel  
Kwiklock

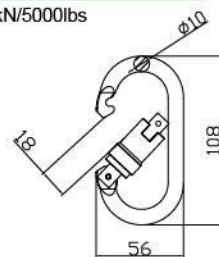

**C Carabiner**  
**CBR-SP-001**

Min. Breaking Strength: 23kN/5000lbs  
Stainless Steel  
Kwiklock

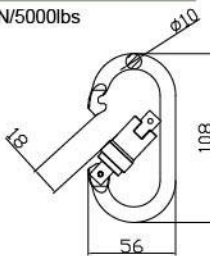

**C Carabiner**  
**CBRA-S10-001**

Min. Breaking Strength: 23kN/5000lbs  
Alloy Steel  
Twist Lock

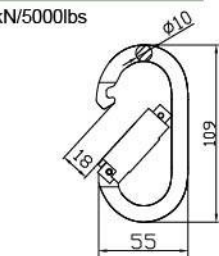

**D Carabiner**  
**CBRD-S-001**

Min. Breaking Strength: 23kN/5000lbs  
Alloy Steel  
Screw Lock

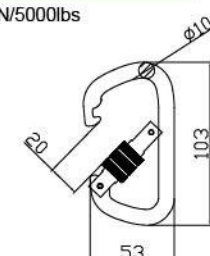

**D Carabiner**  
**CBRD-S-007**

Min. Breaking Strength: 23kN/5000lbs  
Alloy Steel  
Kwiklock

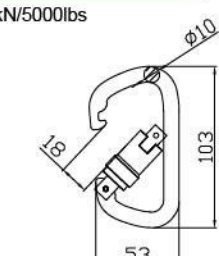

**D Carabiner**  
**CBRD-SP-001**

Min. Breaking Strength: 23kN/5000lbs  
Stainless Steel  
Kwiklock

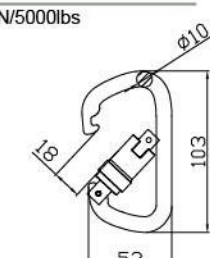

**D Carabiner**  
**CBRAD-S10-001**

Min. Breaking Strength: 23kN/5000lbs  
Alloy Steel  
Twist Lock

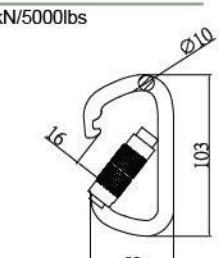

**D Carabiner**  
**CBRAD-S11-001**

Min. Breaking Strength: 23kN/5000lbs  
Alloy Steel  
Twist Lock

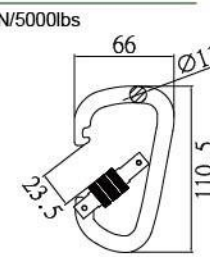

**D Carabiner**  
**CBRAD-F-002**

Min. Breaking Strength: 40kN/8900lbs  
Forged Alloy Steel  
Twist Lock

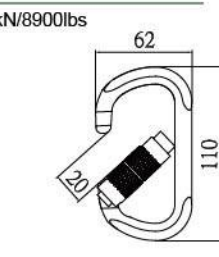

**D1 Carabiner**  
**CBRD1-S-001**

Min. Breaking Strength: 23kN/5000lbs  
Alloy Steel  
Screw Lock

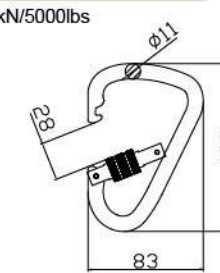

**D1 Carabiner**  
**CBRD1-S-005**

Min. Breaking Strength: 23kN/5000lbs  
Alloy Steel  
Kwiklock

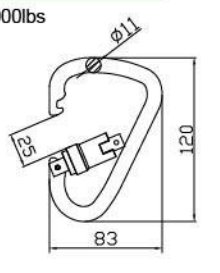

**D Carabiner**  
**CBRD1-S-001**

Min. Breaking Strength: 23kN/5000lbs  
Alloy Steel  
Screw Lock

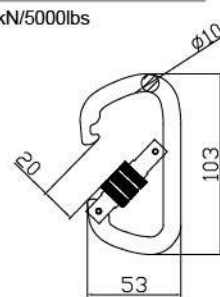

**D Carabiner**  
**CBRD1-S-007**

Min. Breaking Strength: 23kN/5000lbs  
Alloy Steel  
Kwiklock

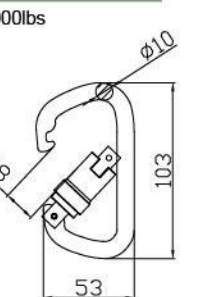

**D1 Carabiner**  
**CBRAD1-S11-001**

Min. Breaking Strength: 23kN/5000lbs  
Alloy Steel  
Twist Lock

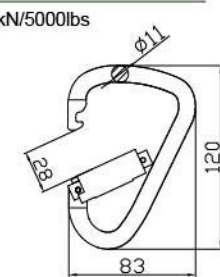

**D1 Carabiner**  
**CBRTD1-F-002**

Min. Breaking Strength: 30kN/6500lbs  
Forged Alloy Steel  
Triple Lock

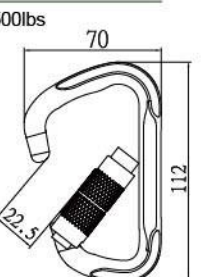

**D1 Carabiner**  
**CBRTD1-F-003**

Min. Breaking Strength: 30kN/6500lbs  
Forged Alloy Steel  
Triple Lock

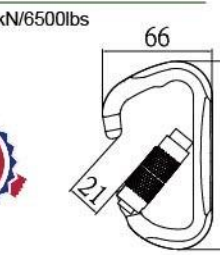

**D1 Carabiner**  
**CBRTD1-F-004**

Min. Breaking Strength: 41kN/9000lbs  
Forged Alloy Steel  
Triple Lock

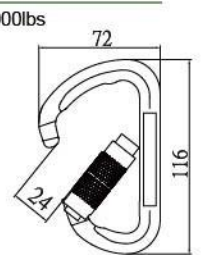

**D1 Carabiner**  
**CBRAD1-S11-002**

Min. Breaking Strength: 23kN/5000lbs  
Alloy Steel  
Twist Lock

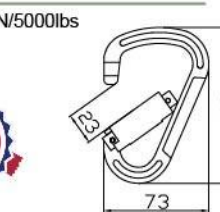

# Steel Carabiner



**WAIST Carabiner**  
**SH01CX-010119**

Min. Breaking Strength: 23kN/5000lbs  
Alloy Steel  
Screw Lock

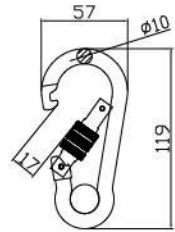

**WAIST Carabiner**  
**SH01CX-100120SP-1**

Min. Breaking Strength: 23kN/5000lbs  
Stainless Steel  
Screw Lock

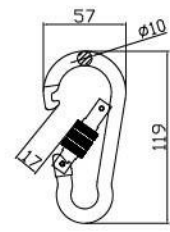

**WAIST Carabiner**  
**SH01KX-100120**

Min. Breaking Strength: 23kN/5000lbs  
Alloy Steel  
Kwiklock

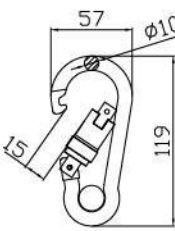

**WAIST Carabiner**  
**SH01AX-100120**

Min. Breaking Strength: 23kN/5000lbs  
Alloy Steel  
Twist Lock

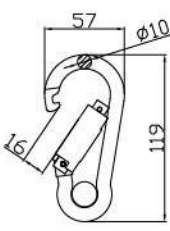

**WAIST Carabiner**  
**SH01TX-F-001**

Min. Breaking Strength: 30kN/6500lbs  
Forged Alloy Steel  
Triple Lock

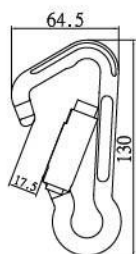

**Large Swivel Carabiner**  
**CBRR-S-001**

Min. Breaking Strength: 23kN/5000lbs  
Alloy Steel  
Kwiklock

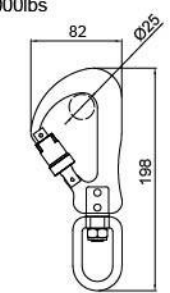

**Medium Swivel Carabiner**  
**CBRR-S-002**

Min. Breaking Strength: 23kN/5000lbs  
Alloy Steel  
Kwiklock

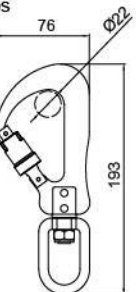

**Small Swivel Carabiner**  
**CBRR-S-003**

Min. Breaking Strength: 23kN/5000lbs  
Alloy Steel  
Kwiklock

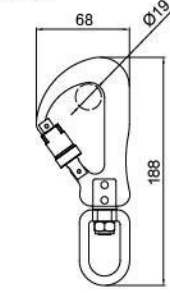

**Swivel Carabiner**  
**CBRR-F-001**

Min. Breaking Strength: 30kN/6500lbs  
Forged Alloy Steel  
Twist Lock

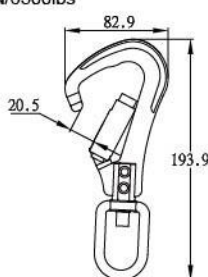

# Aluminum Carabiner



**D Carabiner**  
**CBRAD-ALF-001**

Min. Breaking Strength: 23kN/5000lbs  
Forged Aluminum Alloy  
Twist Lock  
Anodized

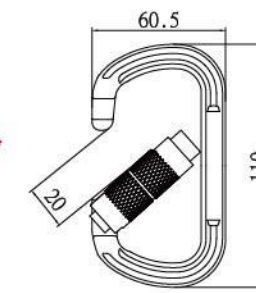

**D Carabiner**  
**CBRAD-ALF-002**

Min. Breaking Strength: 23kN/5000lbs  
Forged Aluminum Alloy  
Twist Lock  
Anodized

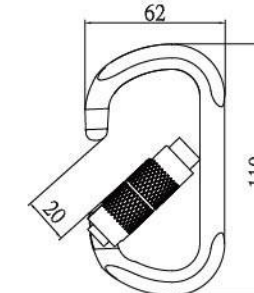

**D Carabiner**  
**CBRD-AL11-001**

Min. Breaking Strength: 23kN/5000lbs  
Aluminum Alloy  
Screw Lock  
Anodized

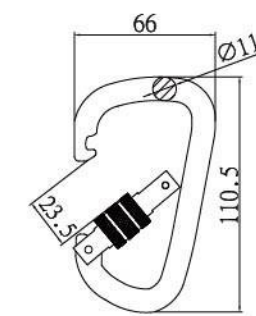

**D1 Carabiner**  
**CBRAD1-ALF-001**

Min. Breaking Strength: 23kN/5000lbs  
Forged Aluminum Alloy  
Twist Lock  
Anodized

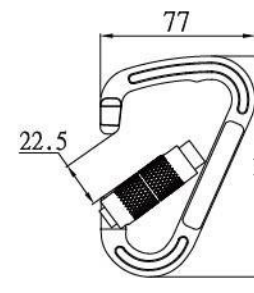

**D1 Carabiner**  
**CBRAD1-ALF-002**

Min. Breaking Strength: 23kN/5000lbs  
Forged Aluminum Alloy  
Twist Lock  
Anodized

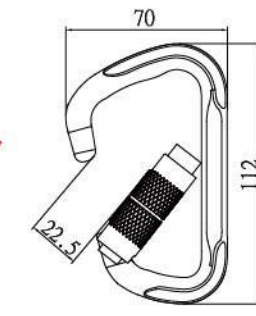

**D1 Carabiner**  
**CBRAD1-ALF-003**

Min. Breaking Strength: 23kN/5000lbs  
Forged Aluminum Alloy  
Twist Lock  
Anodized

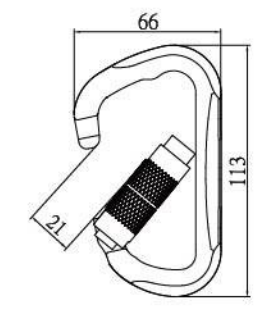

# Aluminum Carabiner



**D1 Carabiner**  
**CBRAD1-ALF-004**  
 Min. Breaking Strength: 23kN/5000lbs  
 Forged Aluminum Alloy  
 Twist Lock  
 Anodized

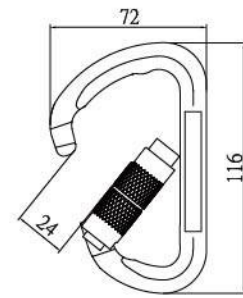

**WAIST Carabiner**  
**SH01AX-ALF-001**  
 Min. Breaking Strength: 23kN/5000lbs  
 Forged Aluminum Alloy  
 Twist Lock  
 Anodized

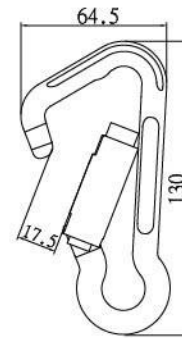

**Carabiner**  
**CBRAD-AL08-001**  
 Min. Breaking Strength: 9kN/2000lbs  
 Aluminum Alloy  
 With Captive Pin  
 Twist Lock  
 Anodized

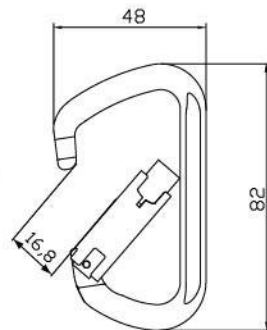

**Quick Connector**  
**LQ02-AL08-001**  
 Min. Breaking Strength: 9kN/2000lbs  
 Aluminum Alloy  
 Quick Lock  
 Anodized

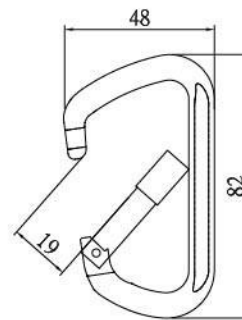

**Swivel Connector**  
**CBRADV-ALF-001**  
 Min. Breaking Strength: 9kN/2000lbs  
 Forged Aluminum Alloy  
 Twist Lock  
 Anodized

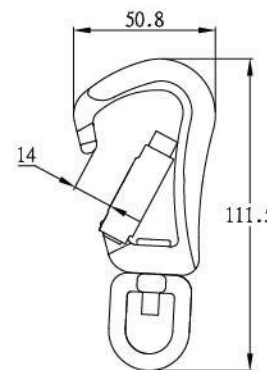

# Fall Protection For Tools

Tool Set with Bungee Rope makes work environments safer and more productive by drastically reducing falling object incidents resulting in personal injury, equipment damage, and tool loss.



**Tool Set with Bungee Rope**  
**TOOL SET-01**  
 Aluminum Swivel Connectors  
 Twist Lock  
 Anodized  
 Bungee Rope 52cm, extended 104cm



# Snap Hook



**Self Locking Rebar Hook**  
**RBH-001**  
 Min. Breaking Strength: 23kN/5000lbs  
 Alloy Steel

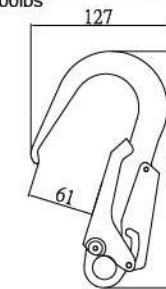

**Aluminum Rebar Hook**  
**RBH-L-AL-002**  
 Min. Breaking Strength: 23kN/5000lbs  
 Forged Aluminum Alloy

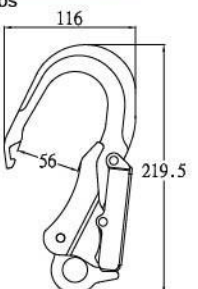

**Self Locking Rebar Hook**  
**RBH-003**  
 Min. Breaking Strength: 23kN/5000lbs  
 Forged Alloy Steel

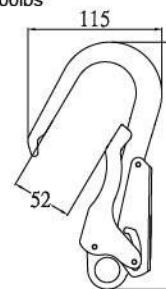

**Self Locking Rebar Hook**  
**RBH-003-1**  
 Min. Breaking Strength: 23kN/5000lbs  
 Forged Alloy Steel  
 Electric Color Plated

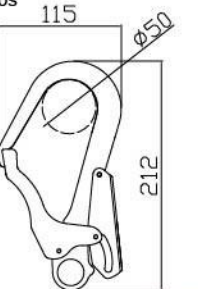

# Snap Hook



**Stamped Rebar Hook**  
**RBH-004**

Min. Breaking Strength: 23kN/5000lbs  
Alloy Steel  
Kwiklock

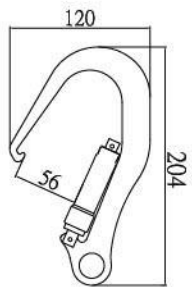

**Eyelet Rebar Hook**  
**RBH-005**

Min. Breaking Strength: 23kN/5000lbs  
Alloy Steel  
Twist Lock

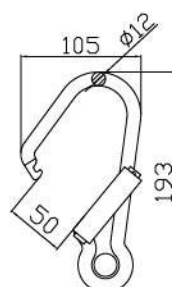

**Self Locking Snap Hook**  
**RBH-M-001**

Min. Breaking Strength: 23kN/5000lbs  
Alloy Steel

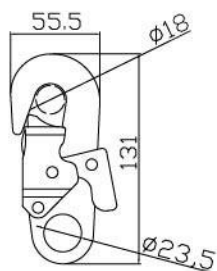

**Self Locking Snap Hook**  
**RBH-S-001**

Min. Breaking Strength: 23kN/5000lbs  
Alloy Steel

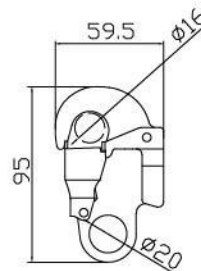

**Self Locking Snap Hook**  
**RBH-M-002**

Min. Breaking Strength: 23kN/5000lbs  
Alloy Steel  
Auto Lock

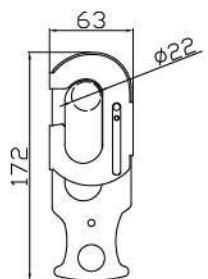

**Self Locking Snap Hook**  
**RBH-M-AL-001**

Min. Breaking Strength: 23kN/5000lbs  
Forged Aluminum Alloy  
Twist Lock

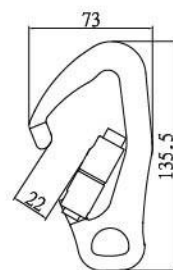

**Screw Locking Snap Hook**  
**RBH-M-AL-002**

Min. Breaking Strength: 23kN/5000lbs  
Forged Aluminum Alloy  
Screw Lock  
Anodized Titanium

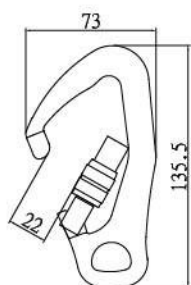

# Safety Buckle



Harness Safety Buckle  
Supplied with various material on the body, bolt and buckle, hooks for varying harness configurations.



**Harness Safety Buckle**  
**HSB-001AL-GG**

Min. Breaking Strength: 12kN/2500lbs  
Aluminum Alloy  
Safety Locking System  
Webbing: 1 3/4" (45mm)  
Net Weight: 75g



**Harness Safety Buckle**  
**HSB-001H1**

Min. Breaking Strength: 15kN/3000lbs  
Alloy Steel  
Safety Locking System  
Webbing: 1 3/4" (45mm)  
Net Weight: 120g



**Harness Safety Buckle**  
**HSB-001SP-1**

Min. Breaking Strength: 10kN/2000lbs  
SUS 304/SUS 316  
Safety Locking System  
Webbing: 1 3/4" (45mm)  
Net Weight: 149 gm

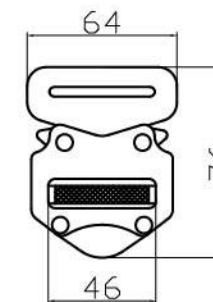

# Swivel Connector



**Swivel Connector**  
**SWC-01**

Min. Breaking Strength: 40kN/8900lbs  
Forged Alloy Steel



**Stainless Swivel Connector**  
**SWC-02**

Min. Breaking Strength: 35kN/7500lbs  
SUS 304/SUS 316



**Aluminum Swivel Connector**  
**SWC-03**

Min. Breaking Strength: 9kN/2000lbs  
Forged Aluminum Alloy  
Anodized Silver



**Aluminum Swivel Connector**  
**SWC-04**

Min. Breaking Strength: 9kN/2000lbs  
Forged Aluminum Alloy  
Anodized Gold



**Aluminum Swivel Connector**  
**SWC-05**

Min. Breaking Strength: 9kN/2000lbs  
Forged Aluminum Alloy  
Anodized Pink

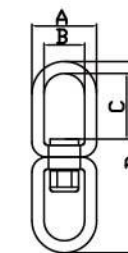

Item No.	A mm	B mm	C mm	D mm
SWC-01/02	43	27	43.5	127
SWC-03/04/05	29.4	17	19.5	69.4